

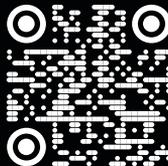

INSTRUCCIONES

INSTRUCTIONS



Visita www.growthejungle.com para consultar las instrucciones y los videos de montaje

Visit www.growthejungle.com for assembly instructions and videos

INSTRUCCIONES

¡Enhorabuena!

Acabas de abrir una caja que contiene algo mucho más importante que una **luminaria LED** de alto rendimiento para cultivo. Estás entrando en un mundo donde cultivar con los amigos y disfrutar de la vida es lo más importante.

Desde **THE JUNGLE** queremos darte las gracias por confiar en nosotros y esperamos acompañarte durante muchos años.

Si quieres asegurarte de que el cultivo salga perfecto, sigue estas breves instrucciones y sírvete del resto de productos **THE JUNGLE**. Nos hemos asegurado de que sean de una calidad óptima para tu cultivo con LED.

Cualquier duda o problema que tengas, contáтанos directamente a:

info@growthejungle.com o llámanos al (+34) 662 935 960 y te ayudaremos inmediatamente.

Y recuerda... **GROW OR DIE!!!**



The **EAGLE**

⚡ 1500w.

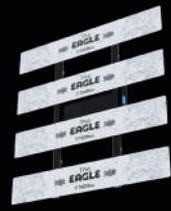

⚡ 1000w.



The **EAGLE NEMESIS**

⚡ 1500w.



⚡ 1000w.



The **HYDRA**

⚡ 600w.



The **HYDRA NEMESIS**



⚡ 600w.

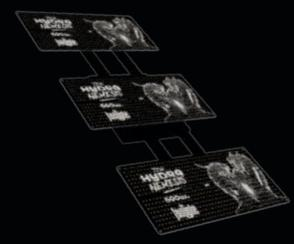

The
EAGLE

The
**EAGLE
NEMESIS**

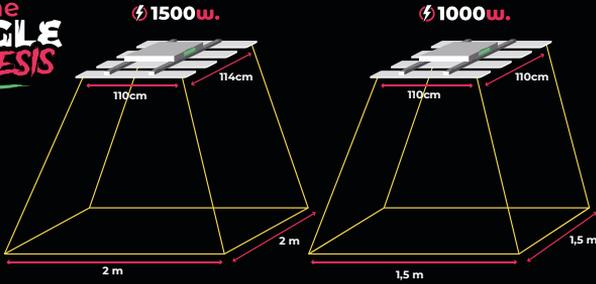

CRECIMIENTO

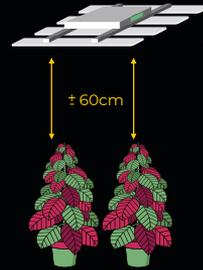

FLORACIÓN

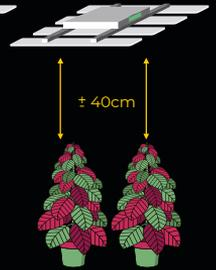

The
HYDRA

The
**HYDRA
NEMESIS**

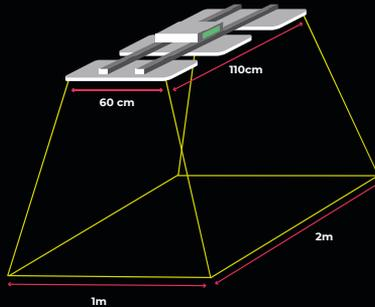

CRECIMIENTO

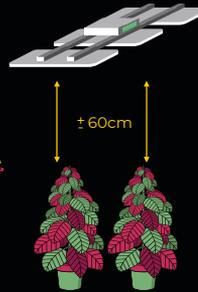

FLORACIÓN

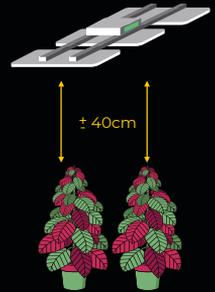

INFORMACIÓN IMPORTANTE



- ▶ No manipules el producto cuando esté conectado a la red eléctrica por riesgo de descarga eléctrica
- ▶ No toques nunca directamente los LED ni los apoyes contra el suelo o superficies sucias o punzantes ni taladres o cortes el producto, podrías dañar los LED o electrocutarte.
- ▶ No sumerjas o mojes el producto podrías provocar un cortocircuito
- ▶ No mires directamente el producto cuando está encendido, podrías tener daños en la retina
- ▶ **¡Atención! No desenchufar los conectores rápidos estando encendido el producto.**



Si tienes algún problema con el producto, **no lo manipules o intentes arreglarlo**, podrías provocar daños tanto personales como materiales. Ponte en contacto con THE JUNGLE en info@growthejungle.com o llámanos al 662 935 960



LISTADO DE COMPONENTES



BASTIDOR PRINCIPAL
(X1 UNIDAD)



CIRCUITOS LED
(X4 UNIDADES)



CLIPS DE UNIÓN DE LOS CIRCUITOS LED AL BASTIDOR PRINCIPAL
(X24 UNIDADES Y 2 EXTRAS, 6 POR CIRCUITO)



INSTRUCCIONES, CATALOGO Y LIFESTYLE



ENCHUFE SCHUKO

PASO 1

- ▶ Desembala el producto con cuidado y coloca el bastidor con los perfiles de aluminio hacia arriba y la caja con el regulador apoyado en el suelo, hacia abajo, en una superficie limpia y plana.

Debes de poder ver los siguientes grupos:

- ▶ 1 Rosas
- ▶ 2 Verdes
- ▶ 3 Blancos
- ▶ 4 Negros

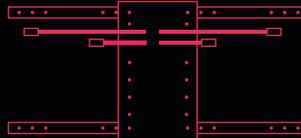

PASO 2

- ▶ Coloca los Circuitos de LED encima del bastidor.
- ▶ Para ello, deberás hacer coincidir cada Circuito de LED con su número y color.

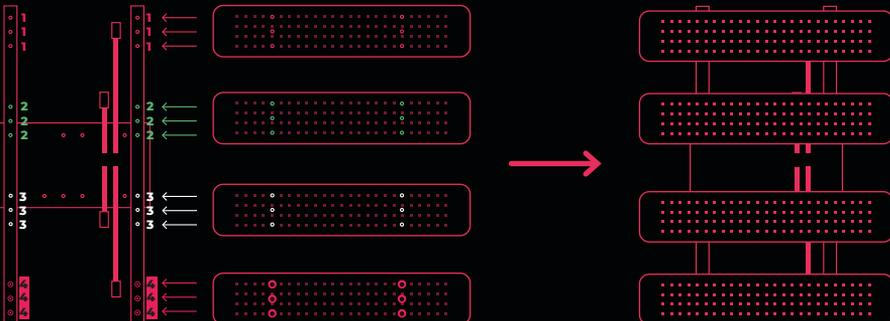

PASO 3

- ▶ En este paso, el objetivo es ir uniendo cada circuito de LED (4 en total) al bastidor principal con los clips suministrados.
- ▶ Debes de poner 3 a cada lado del circuito LED, haciendo un total de 6 clips por circuito
- ▶ Asegúrate de que entran hasta el fondo y escuchas un “click”

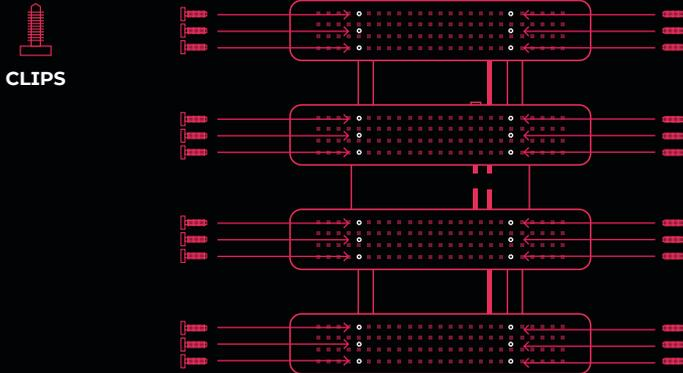

PASO 4

- ▶ Cuelga tu EAGLE en el lugar donde vayas a utilizarlo con cuidado de sujetar la luminaria por los perfiles de aluminio y no por los circuitos LED. Además, asegúrate de que las poleas que utilizas sean capaces de soportar hasta 20kg.
- ▶ Después, conecta los circuitos LED al Driver con los conectores preinstalados.
- ▶ Recuerda que los Circuitos LED y los cables de los conectores hembra y macho están etiquetados con el número y color del circuito correspondiente.
- ▶ ¡Atención! No desenchufar los conectores rápidos estando encendido el producto.

- ▶ 1 Rosas
- ▶ 2 Verdes
- ▶ 3 Blancos
- ▶ 4 Negros

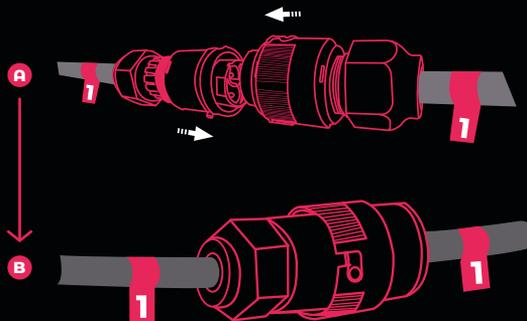

PASO 5

- ▶ Continúa en las páginas 9 y 10 para ver las instrucciones de montaje del conector SCHUKO, del uso de la regulación y para descargar la app mediante código QR para controlarlo vía Bluetooth (opcional).

LISTADO DE COMPONENTES

The HYDRA The HYDRA NEMESIS



BASTIDOR PRINCIPAL
(X1 UNIDAD)



CIRCUITOS LED
(X3 UNIDADES)



**CLIPS DE UNIÓN DE LOS
CIRCUITOS LED AL
BASTIDOR PRINCIPAL**
(X18 UNIDADES Y 2 EXTRAS, 6
POR CIRCUITO)



**INSTRUCCIONES,
CATÁLOGO Y
LIFESTYLE**



**ENCHUFE
SCHUKO**

PASO 1

- ▶ Desembala el producto con cuidado y coloca el bastidor con los perfiles de aluminio hacia arriba y la caja con el regulador apoyado en el suelo, hacia abajo, en una superficie limpia y plana.

Debes de poder ver los siguientes grupos:

- ▶ 1 Rosas
- ▶ 2 Verdes
- ▶ 3 Blancos

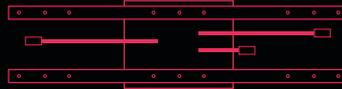

PASO 2

- ▶ Coloca los Circuitos de LED encima del bastidor.
- ▶ Para ello, deberás hacer coincidir cada Circuito de LED con su número y color.

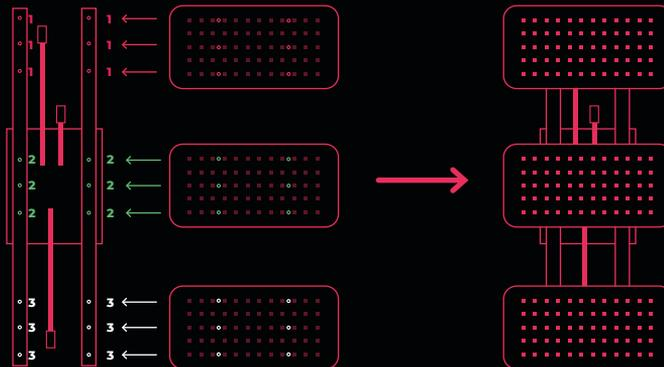

PASO 3

- ▶ En este paso, el objetivo es ir uniendo cada circuito de LED (3 en total) al bastidor principal con los clips suministrados. No te preocupes si partes alguno, vienen varios extras en la bolsita.
- ▶ Debes de poner 3 a cada lado del circuito LED, haciendo un total de 6 clips por circuito
- ▶ Asegúrate de que entran hasta el fondo y escuchas un “click”

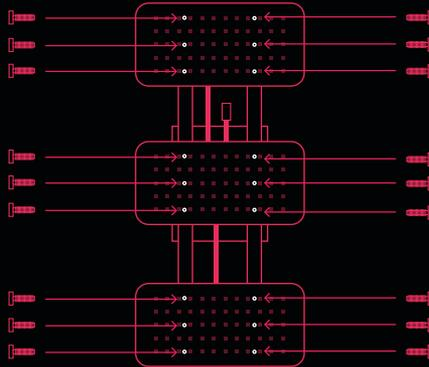

PASO 4

- ▶ Cuelga tu HYDRA en el lugar donde vayas a utilizarlo con cuidado de sujetar la luminaria por los perfiles de aluminio y no por los circuitos LED. Además, asegúrate de que las poleas que utilizas sean capaces de soportar hasta 20kg.
- ▶ Después, conecta los circuitos LED al Driver con los conectores preinstalados.
- ▶ Recuerda que los Circuitos LED y los cables de los conectores hembra y macho están etiquetados con el número y color del circuito correspondiente.
- ▶ ¡Atención! No desenchufar los conectores rápidos estando encendido el producto.

- ▶ 1 Rosas
- ▶ 2 Verdes
- ▶ 3 Blancos

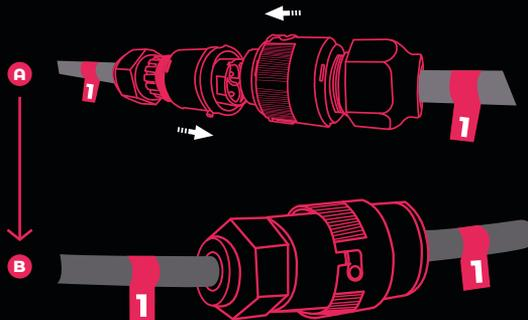

PASO 5

- ▶ Continúa en las páginas 9 y 10 para ver las instrucciones de montaje del conector SCHUKO, del uso de la regulación y para descargar la app mediante código QR para controlarlo vía Bluetooth (opcional).

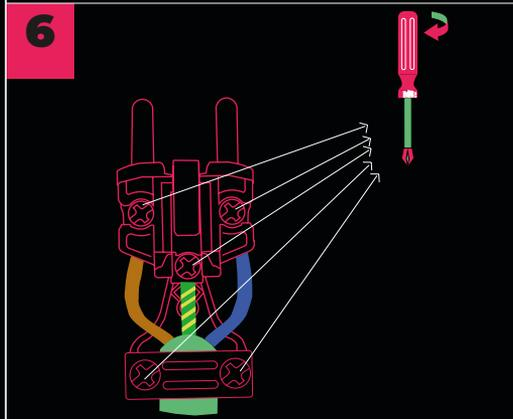
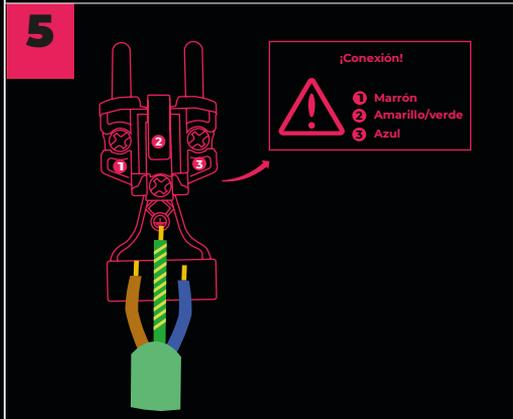
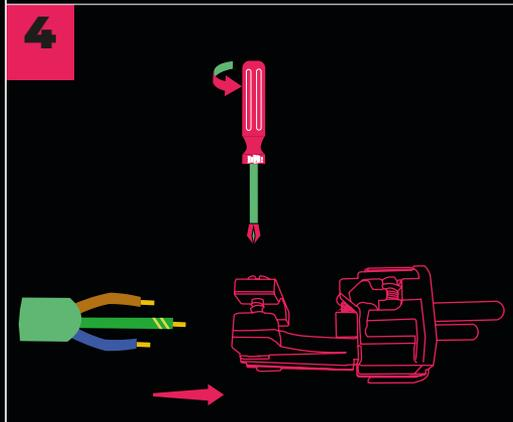
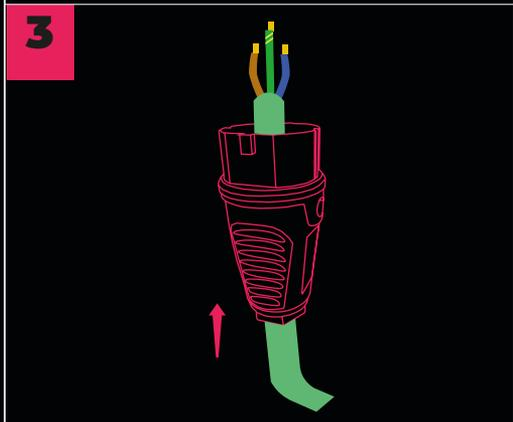
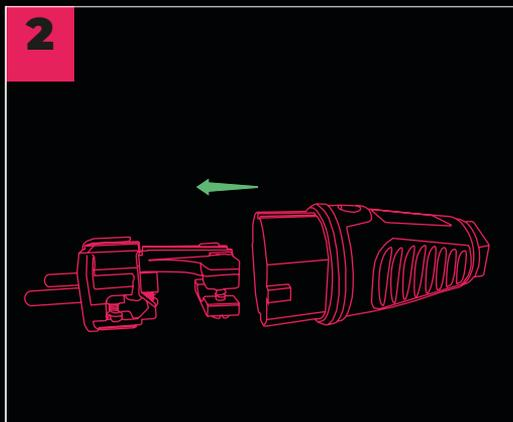
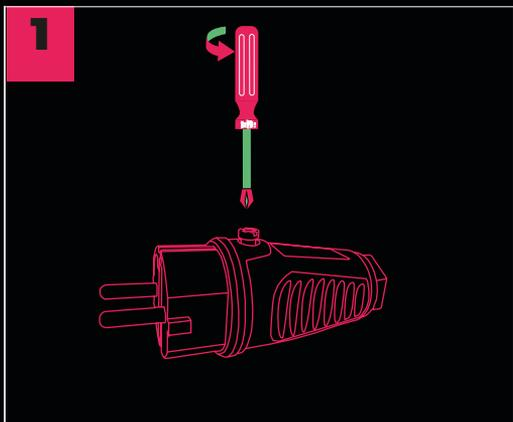

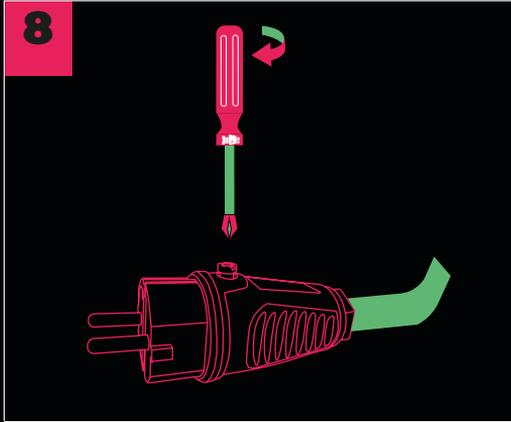
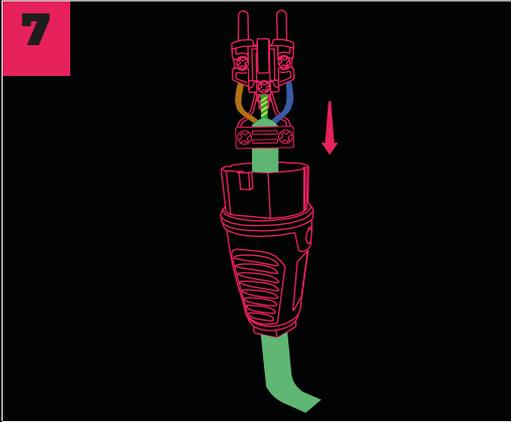

REGULADOR



Vatímetro digital



 Bluetooth™



App para Android



App para iOS

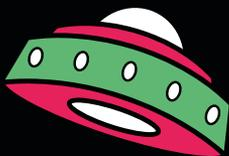

COMUNÍCATE CON NOSOTROS

Si tienes algún problema o quieres resolver alguna duda, ponte en contacto con nosotros, tan pronto como podamos te abduciremos y resolveremos tus dudas.

info@growthejungle.com

(+34) 662 935 960

MIRA MÁS PRODUCTOS EN NUESTRA TIENDA

Encuentra más productos para el cultivo de la jungla, pronto habrá muchas novedades y sorpresas, ¡no te lo pierdas!

www.growthejungle.com



ECHA UN OJO

Si quieres estar al tanto de novedades del sector y de nuestros nuevos productos, únete a nosotros en Instagram.

[@grow_the_jungle](https://www.instagram.com/grow_the_jungle)

NO TE COMAS EL COCO

Todos nuestros productos están fabricados en España y ofrecen seguridad y garantía, además de un excelente servicio postventa. Ya es hora de que cultivar esté al alcance de todos y todas, así que **GROW OR DIE**.



GROW ©





OR DIE

rage

growthejungle.com

@grow_the_jungle



INSTRUCTIONS

Congratulations!

You've just opened a box that contains something far more important than a high performance **LED grow light**. You are entering a world where growing with friend and enjoying life is the most important thing.

From **THE JUNGLE** we want to thank you for trusting us and we hope to accompany you for many years to come.

If you want to make sure that the crop turns out perfectly, follow these brief instructions.; We have made sure that they are of optimum quality for your LED grow.

If you have any questions or problems, please contact us directly at:

info@growthejungle.com o call us at **(+34) 662 935 960** and we will help you immediately.

And remember... **GROW OR DIE!!!**



The
EAGLE

⚡ 1500w.

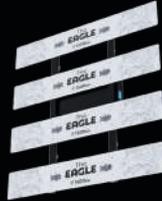

⚡ 1000w.

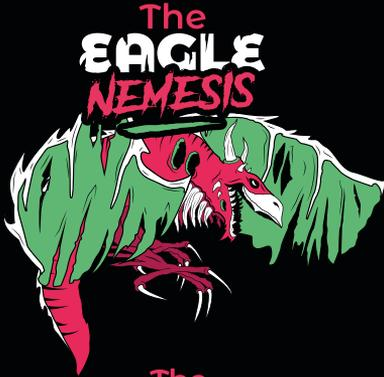

The
EAGLE NEMESIS

⚡ 1500w.

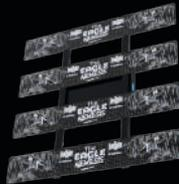

⚡ 1000w.



The
HYDRA

⚡ 600w.



The
HYDRA NEMESIS



⚡ 600w.

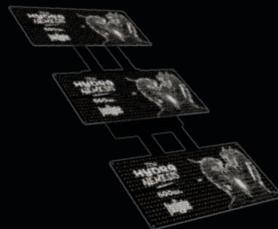



The EAGLE

The EAGLE NEMESIS

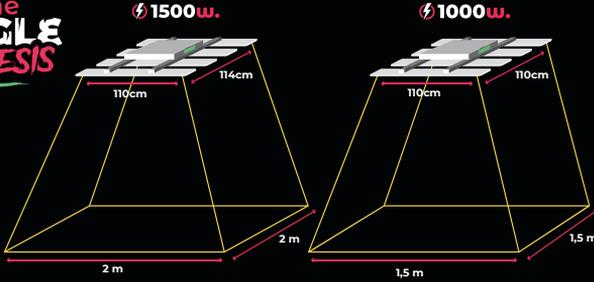

VEGETATIVE

FLOWERING

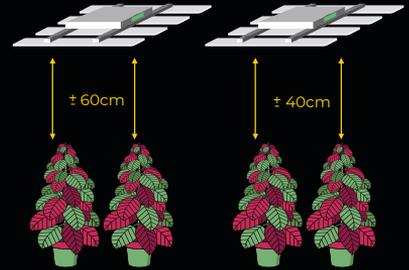

The HYDRA

The HYDRA NEMESIS

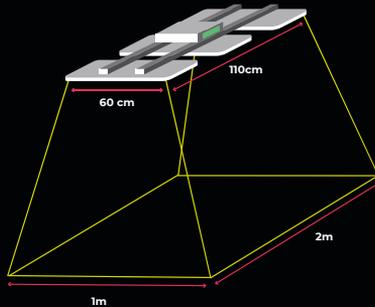

VEGETATIVE

FLOWERING

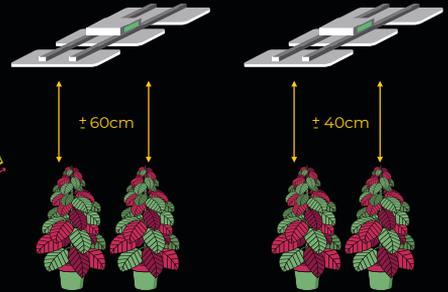

IMPORTANT INFORMATION



- ▶ Do not handle the product when it is connected to the electrical network due to the risk of electric shock.
- ▶ Never touch the LEDs directly or lean them against the floor or dirty/sharp surfaces. Do not drill or cut the product, you could damage the LEDs or electrocute yourself.
- ▶ Do not immerse or wet the product as this may cause a short circuit.
- ▶ Do not look directly at the product when it is on, you could have damage to your retina.
- ▶ **Caution! Do not unplug the quick connectors when the product is switched on.**



If you have any problem with the product, do not manipulate it or try to fix it, you could cause personal and material damage. Contact **THE JUNGLE** at info@growthejungle.com or call us at **(+34) 662 935 960**.



COMPONENTS LIST

The EAGLE The EAGLE NEMESIS



MAIN FRAME
(X1 UNIT)



LED CIRCUITS
(X4 UNITS)



CLIPS FOR ATTACHING LED CIRCUITS TO THE MAIN FRAME
(X24 PIECES + 2 EXTRAS, 6 PIECES PER LED BOARD)



MANUAL, CATALOGUE AND LIFESTYLE



SHUKO PLUG

STEP 1

- ▶ Carefully unpack the product and place the frame with the aluminium profiles facing upwards and the box with the regulator resting on the floor on a clean, flat surface.

You should be able to see the following groups:

- ▶ 1 Pinks
- ▶ 2 Greens
- ▶ 3 Whites
- ▶ 4 Blacks

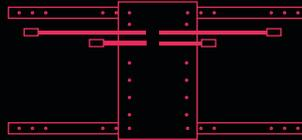

STEP 2

- ▶ Place the LED Circuit Boards on top of the frame.
- ▶ To do this, you must match each LED Circuit with its number and colour

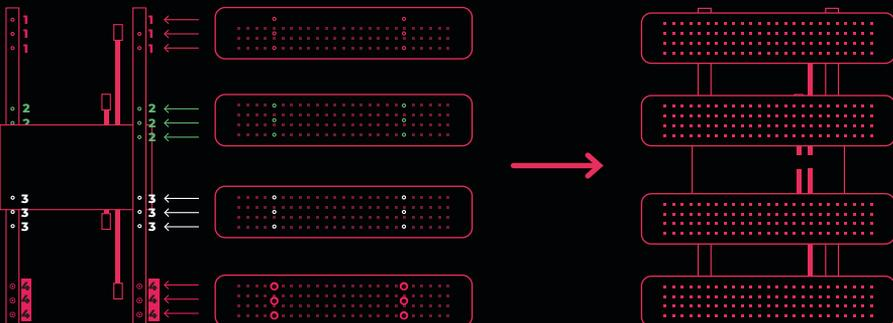

STEP 3

- ▶ In this step, the aim is to attach each LED circuit (4 in total) to the main frame with the supplied clips.
- ▶ You should put 3 clips on each side of the LED circuit, making a total of 6 clips per circuit.
- ▶ Make sure that you install correctly, you must hear a “click” when you tighten the clip

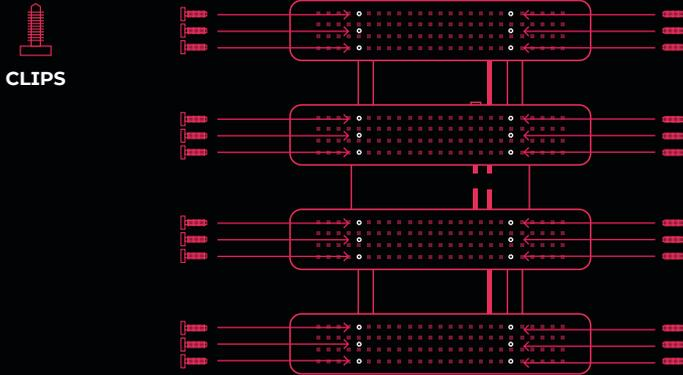

STEP 4

- ▶ Hang your EAGLE where you are going to use it, taking care to hold the luminaire by the aluminium profiles and not by the LED circuits. Also, make sure that the Rope Hanging Ratchets you use are capable of supporting up to 20kg
- ▶ Next step, connect the LED circuits to the Driver with the pre-installed connectors
- ▶ Remember that the LED circuits and the wires of the female and male connectors are labelled with the corresponding circuit number and colour
- ▶ Caution! Do not unplug the quick connectors when the product is switched on

- ▶ 1 Pinks
- ▶ 2 Greens
- ▶ 3 Whites
- ▶ 4 Blacks

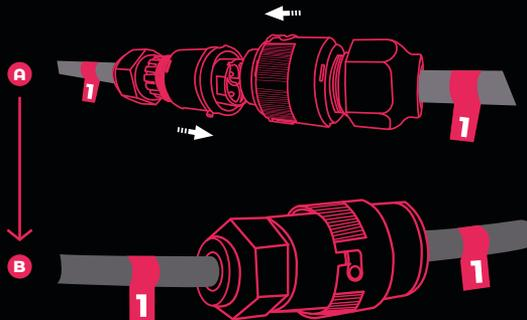

STEP 5

- ▶ See pages 19 and 20 for instructions on how to install the SCHUKO connector, how to use the dimmer and how to download the app via QR code for control via Bluetooth (optional).

LISTADO DE COMPONENTES

The HYDRA The HYDRA NEMESIS

COMPONENTS LIST



MAIN FRAME
(X1 UNIT)



LED CIRCUITS
(X 3 UNITS)



CLIPS FOR ATTACHING LED
CIRCUITS TO THE MAIN
FRAME
(X18 PIECES + 2 EXTRAS, 6
PIECES PER LED BOARD)



MANUAL,
CATALOGUE AND
LIFESTYLE



SHUCKO
PLUG

STEP 1

- ▶ Carefully unpack the product and place the frame with the aluminium profiles facing upwards and the box with the regulator resting on the floor on a clean, flat surface.

You should be able to see the following groups:

- ▶ 1 Pinks
- ▶ 2 Greens
- ▶ 3 Whites

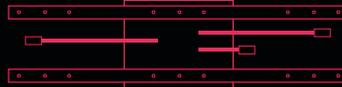

STEP 2

- ▶ Place the LED Circuit Boards on top of the frame.
- ▶ To do this, you must match each LED Circuit with its number and colour

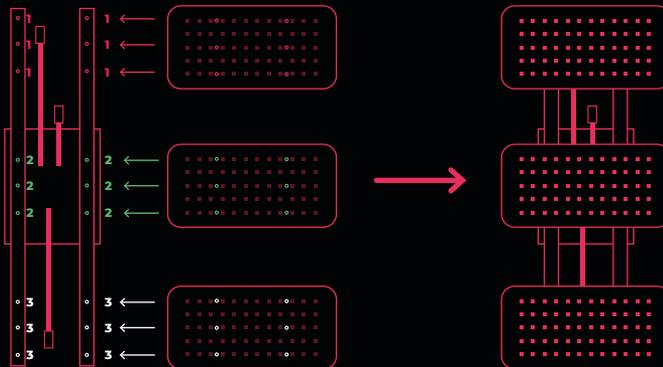

STEP 3

- ▶ In this step, the aim is to attach each LED circuit (3 in total) to the main frame with the supplied clips.
- ▶ You should put 3 clips on each side of the LED circuit, making a total of 6 clips per circuit.
- ▶ Make sure that you install correctly, you must hear a “click” when you tighten the clip

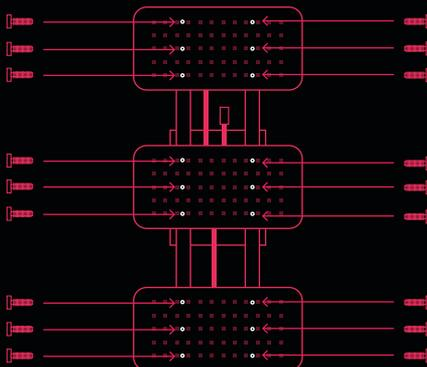

STEP 4

- ▶ Hang your HYDRA where you are going to use it, taking care to hold the luminaire by the aluminium profiles and not by the LED circuits. Also, make sure that the Rope Hanging Ratchets you use are capable of supporting up to 20kg
- ▶ Next step, connect the LED circuits to the Driver with the pre-installed connectors
- ▶ Remember that the LED circuits and the wires of the female and male connectors are labelled with the corresponding circuit number and colour
- ▶ Caution! Do not unplug the quick connectors when the product is switched on

- ▶ 1 Pinks
- ▶ 2 Greens
- ▶ 3 Whites

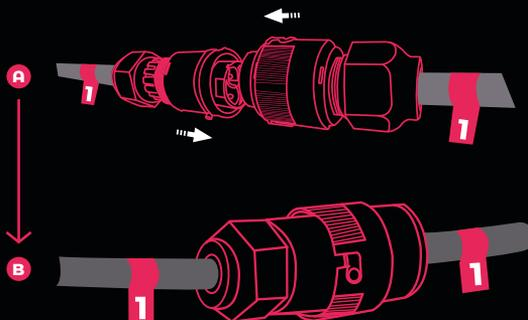

STEP 5

- ▶ See pages 19 and 20 for instructions on how to install the SCHUKO connector, how to use the dimmer and how to download the app via QR code for control via Bluetooth (optional)

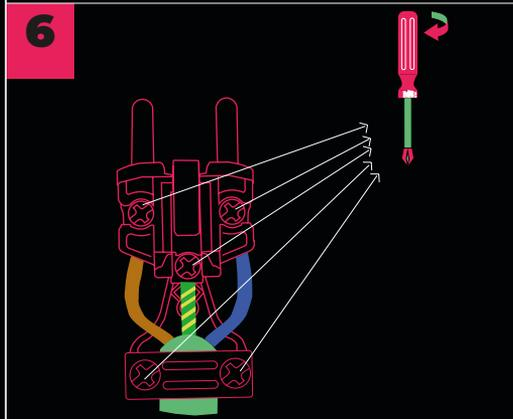
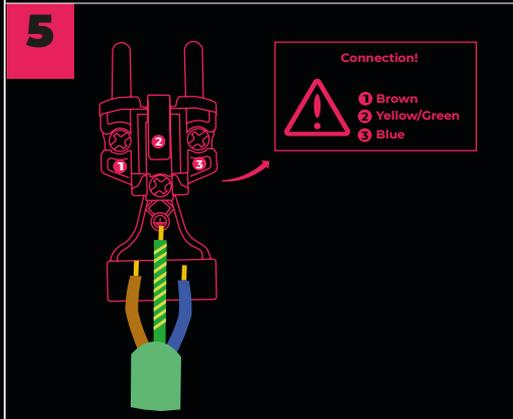
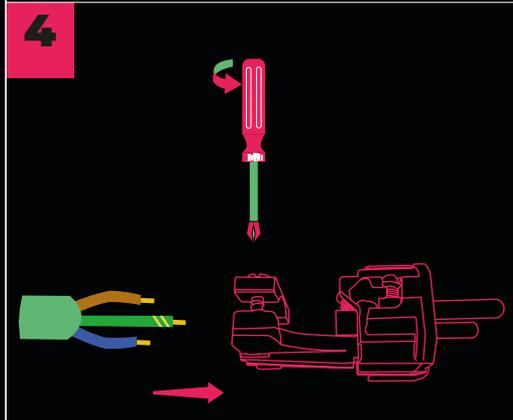
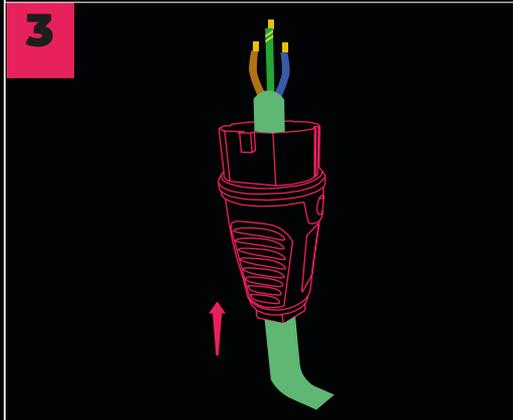
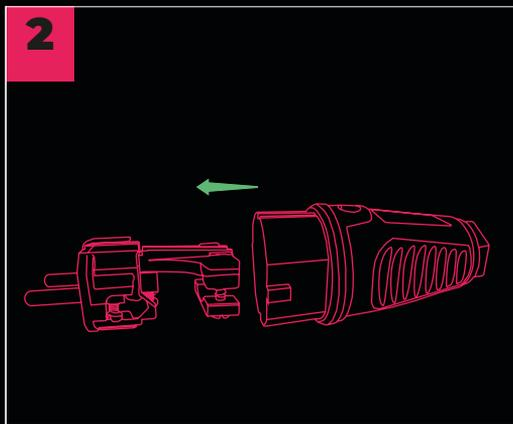
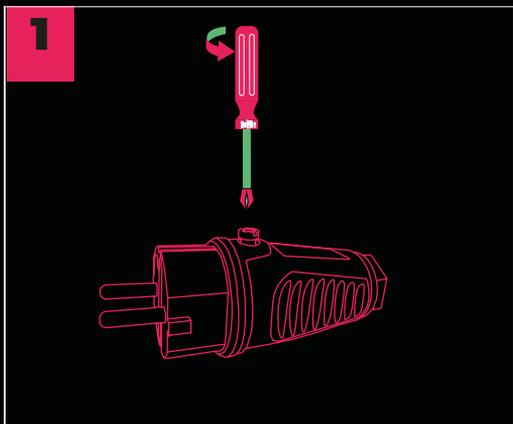

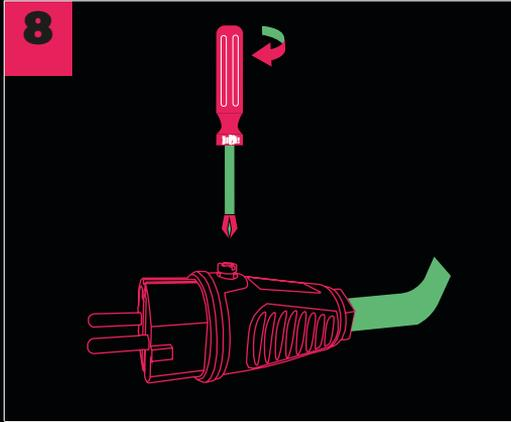
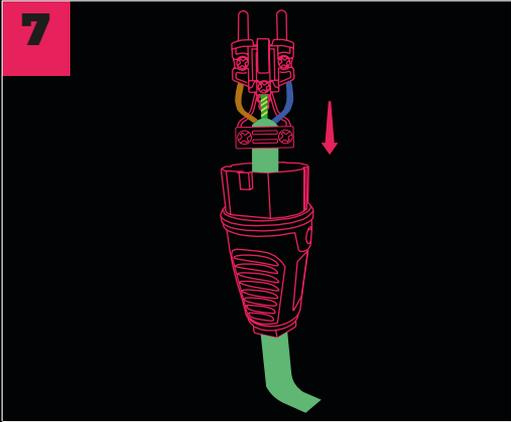

DIMMING



Potentiometer



Bluetooth™



App for Android



App for iOS

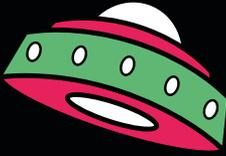

CONTACT US

If you have any problem or want to solve any doubt, contact us, as soon as we can we can we will abduct you and solve your doubts.

info@growthejungle.com

(+34) 662 935 960

CHECK OUT MORE PRODUCTS IN OUR SHOP

Find more products for the cultivation of the jungle, soon there will be many news and surprises, do not miss it!!

www.growthejungle.com



TAKE A LOOK

If you want to keep abreast of the latest advances of the sector and our new products, join us at Instagram

[@grow_the_jungle](https://www.instagram.com/grow_the_jungle)

DON'T BROOD OVER

All our products are made in Spain and offer safety and guarantee, as well as an excellent after-sales service. It's time to make growing affordable for everyone, so GROW OR DIE.



